

MJH11017, MJH11019, MJH11021 (PNP) MJH11018, MJH11020, MJH11022 (NPN)

Preferred Device

Complementary Darlington Silicon Power Transistors

These devices are designed for use as general purpose amplifiers, low frequency switching and motor control applications.

Features

- High DC Current Gain @ 10 Adc — $h_{FE} = 400$ Min (All Types)
- Collector–Emitter Sustaining Voltage
 $V_{CEO(sus)} = 150$ Vdc (Min) — MJH11018, 17
 $= 200$ Vdc (Min) — MJH11020, 19
 $= 250$ Vdc (Min) — MJH11022, 21
- Low Collector–Emitter Saturation Voltage
 $V_{CE(sat)} = 1.2$ V (Typ) @ $I_C = 5.0$ A
 $= 1.8$ V (Typ) @ $I_C = 10$ A
- Monolithic Construction
- Pb–Free Packages are Available*

MAXIMUM RATINGS

Rating	Symbol	Max	Unit
Collector–Emitter Voltage MJH11018, MJH11017 MJH11020, MJH11019 MJH11022, MJH11021	V_{CEO}	150 200 250	Vdc
Collector–Base Voltage MJH11018, MJH11017 MJH11020, MJH11019 MJH11022, MJH11021	V_{CB}	150 200 250	Vdc
Emitter–Base Voltage	V_{EB}	5.0	Vdc
Collector Current – Continuous – Peak (Note 1)	I_C	15 30	Adc
Base Current	I_B	0.5	Adc
Total Device Dissipation @ $T_C = 25^\circ\text{C}$ Derate above 25°C	P_D	150 1.2	W W/ $^\circ\text{C}$
Operating and Storage Junction Temperature Range	T_J, T_{stg}	–65 to +150	$^\circ\text{C}$

THERMAL CHARACTERISTICS

Characteristic	Symbol	Max	Unit
Thermal Resistance, Junction–to–Case	$R_{\theta JC}$	0.83	$^\circ\text{C/W}$

Stresses exceeding Maximum Ratings may damage the device. Maximum Ratings are stress ratings only. Functional operation above the Recommended Operating Conditions is not implied. Extended exposure to stresses above the Recommended Operating Conditions may affect device reliability.

1. Pulse Test: Pulse Width = 5.0 ms, Duty Cycle $\leq 10\%$.

*For additional information on our Pb–Free strategy and soldering details, please download the ON Semiconductor Soldering and Mounting Techniques Reference Manual, SOLDERRM/D.



ON Semiconductor®

<http://onsemi.com>

15 AMPERE DARLINGTON COMPLEMENTARY SILICON POWER TRANSISTORS 150–250 VOLTS, 150 WATTS

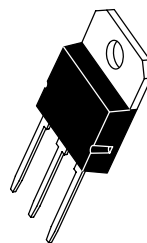

SOT-93
(TO-218)
CASE 340D
STYLE 1

MARKING DIAGRAM

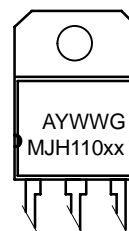

A = Assembly Location
Y = Year
WW = Work Week
G = Pb–Free Package
MJH110xx = Device Code
xx = 17, 19, 21, 18, 20, 22

ORDERING INFORMATION

Device	Package	Shipping
MJH11017	SOT-93	30 Units / Rail
MJH11017G	SOT-93 (Pb–Free)	30 Units / Rail
MJH11018	SOT-93	30 Units / Rail
MJH11018G	SOT-93 (Pb–Free)	30 Units / Rail
MJH11019	SOT-93	30 Units / Rail
MJH11019G	SOT-93 (Pb–Free)	30 Units / Rail
MJH11020	SOT-93	30 Units / Rail
MJH11020G	SOT-93 (Pb–Free)	30 Units / Rail
MJH11021	SOT-93	30 Units / Rail
MJH11021G	SOT-93 (Pb–Free)	30 Units / Rail
MJH11022	SOT-93	30 Units / Rail
MJH11022G	SOT-93 (Pb–Free)	30 Units / Rail

Preferred devices are recommended choices for future use and best overall value.

MJH11017, MJH11019, MJH11021 (PNP) MJH11018, MJH11020, MJH11022 (NPN)

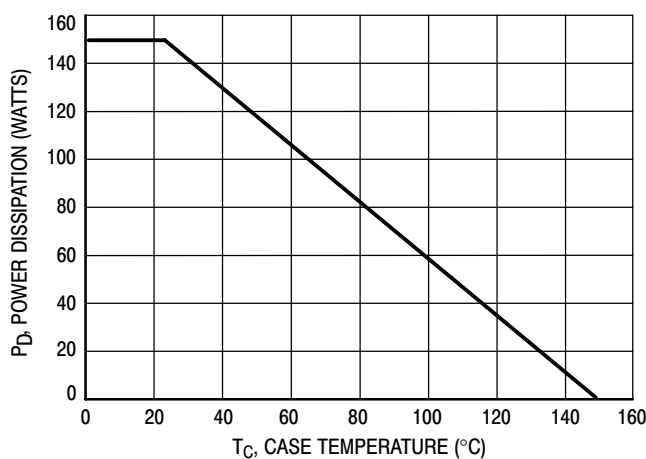

Figure 1. Power Derating

ELECTRICAL CHARACTERISTICS (T_C = 25°C unless otherwise noted)

Characteristic	Symbol	Min	Max	Unit
OFF CHARACTERISTICS				
Collector–Emitter Sustaining Voltage (Note 2) (I _C = 0.1 Adc, I _B = 0)	V _{CEO(sus)}	150 200 250	– – –	Vdc
Collector Cutoff Current (V _{CE} = 75 Vdc, I _B = 0) (V _{CE} = 100 Vdc, I _B = 0) (V _{CE} = 125 Vdc, I _B = 0)	I _{CEO}	– – –	1.0 1.0 1.0	mAdc
Collector Cutoff Current (V _{CE} = Rated V _{CB} , V _{BE(off)} = 1.5 Vdc) (V _{CE} = Rated V _{CB} , V _{BE(off)} = 1.5 Vdc, T _J = 150°C)	I _{CEV}	– –	0.5 5.0	mAdc
Emitter Cutoff Current (V _{BE} = 5.0 Vdc I _C = 0)	I _{EBO}	–	2.0	mAdc

ON CHARACTERISTICS (Note 2)

DC Current Gain (I _C = 10 Adc, V _{CE} = 5.0 Vdc) (I _C = 15 Adc, V _{CE} = 5.0 Vdc)	h _{FE}	400 100	15,000 –	–
Collector–Emitter Saturation Voltage (I _C = 10 Adc, I _B = 100 mA) (I _C = 15 Adc, I _B = 150 mA)	V _{CE(sat)}	– –	2.5 4.0	Vdc
Base–Emitter On Voltage (I _C = 10 A, V _{CE} = 5.0 Vdc)	V _{BE(on)}	–	2.8	Vdc
Base–Emitter Saturation Voltage (I _C = 15 Adc, I _B = 150 mA)	V _{BE(sat)}	–	3.8	Vdc

DYNAMIC CHARACTERISTICS

Current–Gain Bandwidth Product (I _C = 10 Adc, V _{CE} = 3.0 Vdc, f = 1.0 MHz)	f _T	3.0	–	–
Output Capacitance (V _{CB} = 10 Vdc, I _E = 0, f = 0.1 MHz)	C _{ob}	– –	400 600	pF
Small–Signal Current Gain (I _C = 10 Adc, V _{CE} = 3.0 Vdc, f = 1.0 kHz)	h _{fe}	75	–	–

SWITCHING CHARACTERISTICS

Characteristic	Symbol	Typical		Unit
		NPN	PNP	
Delay Time	t _d	150	75	ns
Rise Time	t _r	1.2	0.5	μs
Storage Time	t _s	4.4	2.7	μs
Fall Time	t _f	2.5	2.5	μs

(V_{CC} = 100 V, I_C = 10 A, I_B = 100 mA
V_{BE(off)} = 5.0 V) (See Figure 2)

2. Pulse Test: Pulse Width = 300 μs, Duty Cycle ≤ 2.0%.

MJH11017, MJH11019, MJH11021 (PNP) MJH11018, MJH11020, MJH11022 (NPN)

R_B & R_C varied to obtain desired current levels
 D_1 , must be fast recovery types, e.g.:
 1N5825 used above $I_B \approx 100$ mA
 MSD6100 used below $I_B \approx 100$ mA

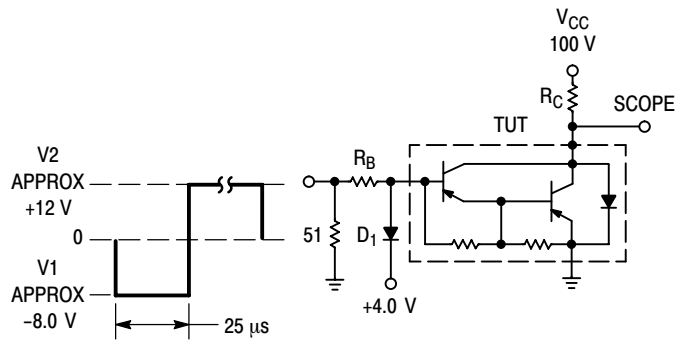

For t_d and t_r , D_1 is disconnected and $V_2 = 0$

$t_r, t_f \leq 10$ ns

Duty Cycle = 1.0%

For NPN test circuit, reverse diode and voltage polarities.

Figure 2. Switching Times Test Circuit

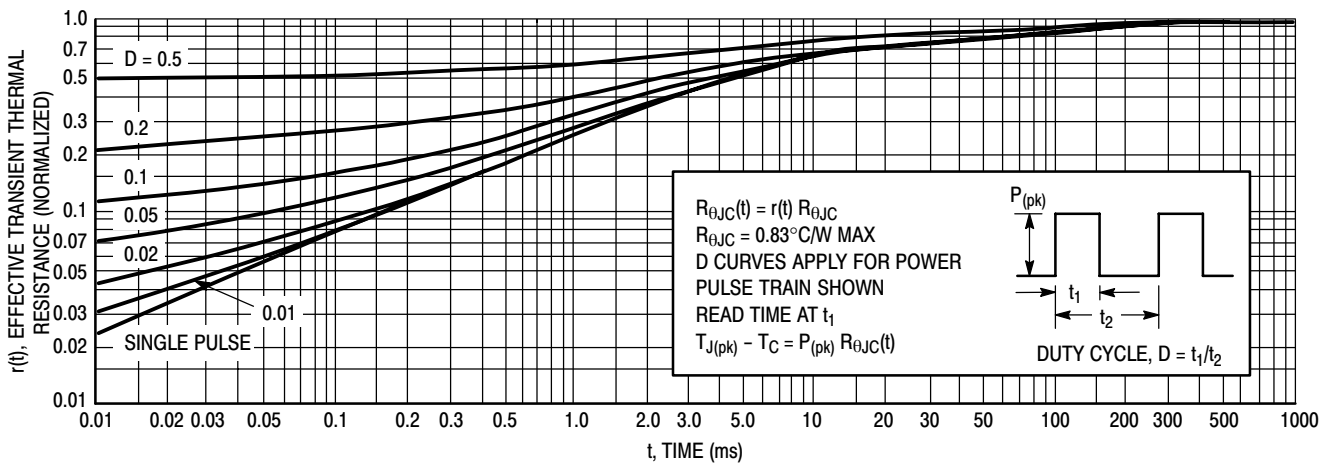

Figure 3. Thermal Response

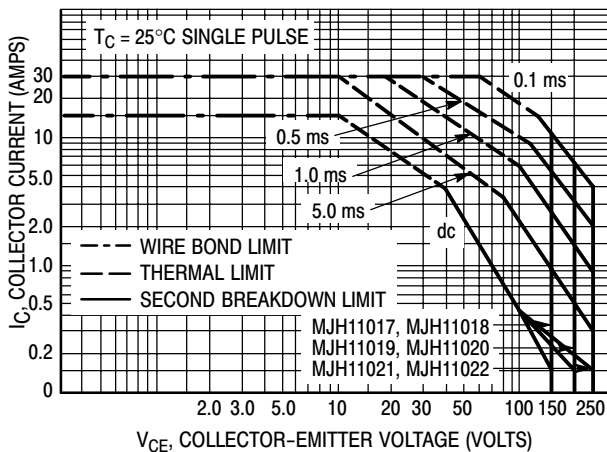

Figure 4. Maximum Rated Forward Bias Safe Operating Area (FBSOA)

FORWARD BIAS

There are two limitations on the power handling ability of a transistor: average junction temperature and second breakdown. Safe operating area curves indicate $I_C - V_{CE}$ limits of the transistor that must be observed for reliable operation; i.e., the transistor must not be subjected to greater dissipation than the curves indicate.

The data of Figure 4 is based on $T_{J(pk)} = 150^\circ\text{C}$; T_C is variable depending on conditions. Second breakdown pulse limits are valid for duty cycles to 10% provided $T_{J(pk)} \leq 150^\circ\text{C}$. $T_{J(pk)}$ may be calculated from the data in Figure 3. At high case temperatures, thermal limitations will reduce the power that can be handled to values less than the limitations imposed by second breakdown.

MJH11017, MJH11019, MJH11021 (PNP) MJH11018, MJH11020, MJH11022 (NPN)

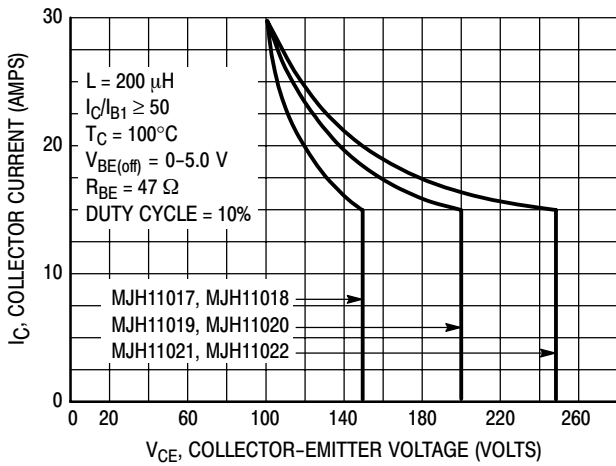

Figure 5. Maximum Rated Reverse Bias Safe Operating Area (RBSOA)

REVERSE BIAS

For inductive loads, high voltage and high current must be sustained simultaneously during turn-off, in most cases, with the base to emitter junction reverse biased. Under these conditions the collector voltage must be held to a safe level at or below a specific value of collector current. This can be accomplished by several means such as active clamping, RC snubbing, load line shaping, etc. The safe level for these devices is specified as Reverse Bias Safe Operating Area and represents the voltage-current conditions during reverse biased turn-off. This rating is verified under clamped conditions so that the device is never subjected to an avalanche mode. Figure 5 gives RBSOA characteristics.

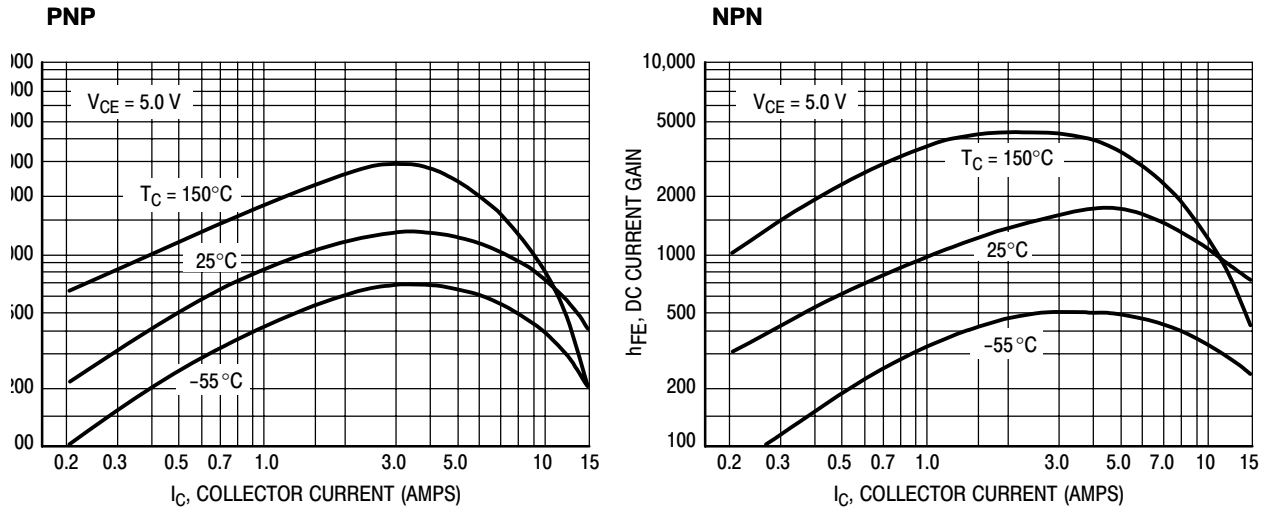

Figure 6. DC Current Gain

MJH11017, MJH11019, MJH11021 (PNP) MJH11018, MJH11020, MJH11022 (NPN)

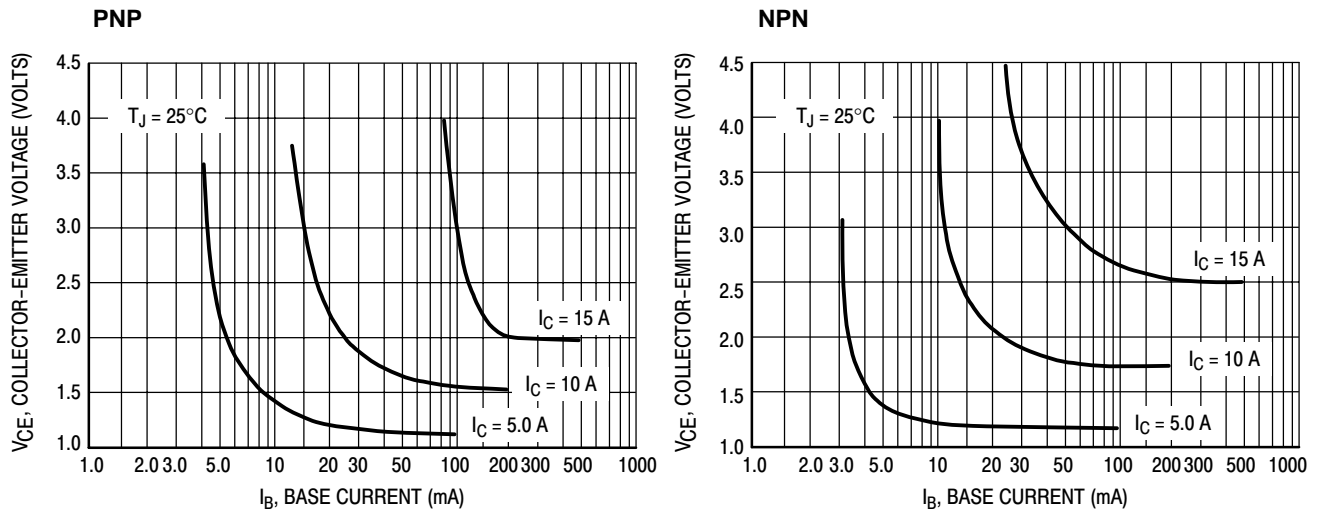

Figure 7. Collector Saturation Region

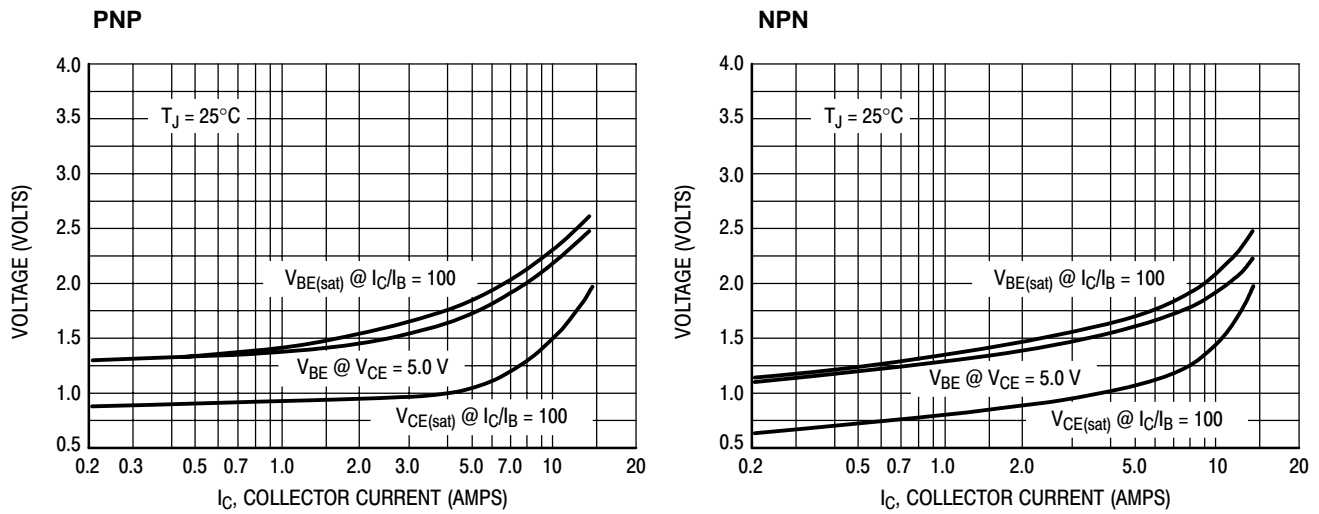

Figure 8. "On" Voltages

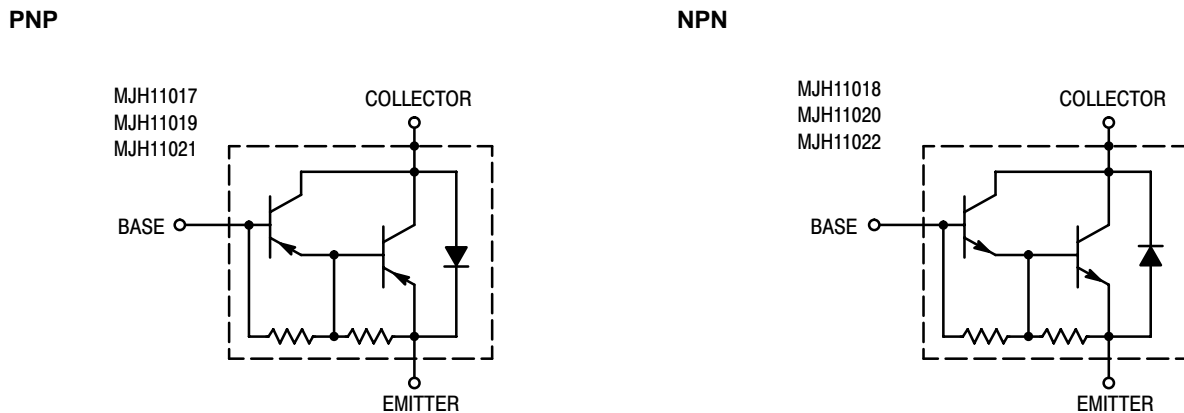
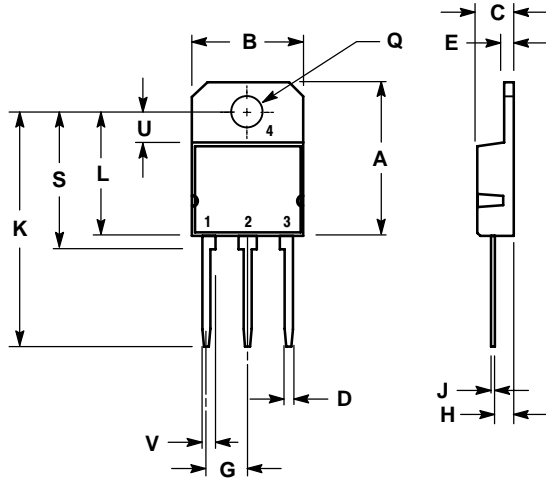

Figure 9. Darlington Schematic

MJH11017, MJH11019, MJH11021 (PNP) MJH11018, MJH11020, MJH11022 (NPN)

PACKAGE DIMENSIONS

SOT-93 (TO-218) CASE 340D-02 ISSUE E



- NOTES:
1. DIMENSIONING AND TOLERANCING PER ANSI Y14.5M, 1982.
2. CONTROLLING DIMENSION: MILLIMETER.

DIM	MILLIMETERS		INCHES	
	MIN	MAX	MIN	MAX
A	---	20.35	---	0.801
B	14.70	15.20	0.579	0.598
C	4.70	4.90	0.185	0.193
D	1.10	1.30	0.043	0.051
E	1.17	1.37	0.046	0.054
G	5.40	5.55	0.213	0.219
H	2.00	3.00	0.079	0.118
J	0.50	0.78	0.020	0.031
K	31.00 REF		1.220 REF	
L	---	16.20	---	0.638
Q	4.00	4.10	0.158	0.161
S	17.80	18.20	0.701	0.717
U	4.00 REF		0.157 REF	
V	1.75 REF		0.069	

- STYLE 1:
PIN 1. BASE
2. COLLECTOR
3. EMITTER
4. COLLECTOR

ON Semiconductor and are registered trademarks of Semiconductor Components Industries, LLC (SCILLC). SCILLC reserves the right to make changes without further notice to any products herein. SCILLC makes no warranty, representation or guarantee regarding the suitability of its products for any particular purpose, nor does SCILLC assume any liability arising out of the application or use of any product or circuit, and specifically disclaims any and all liability, including without limitation special, consequential or incidental damages. "Typical" parameters which may be provided in SCILLC data sheets and/or specifications can and do vary in different applications and actual performance may vary over time. All operating parameters, including "Typicals" must be validated for each customer application by customer's technical experts. SCILLC does not convey any license under its patent rights nor the rights of others. SCILLC products are not designed, intended, or authorized for use as components in systems intended for surgical implant into the body, or other applications intended to support or sustain life, or for any other application in which the failure of the SCILLC product could create a situation where personal injury or death may occur. Should Buyer purchase or use SCILLC products for any such unintended or unauthorized application, Buyer shall indemnify and hold SCILLC and its officers, employees, subsidiaries, affiliates, and distributors harmless against all claims, costs, damages, and expenses, and reasonable attorney fees arising out of, directly or indirectly, any claim of personal injury or death associated with such unintended or unauthorized use, even if such claim alleges that SCILLC was negligent regarding the design or manufacture of the part. SCILLC is an Equal Opportunity/Affirmative Action Employer. This literature is subject to all applicable copyright laws and is not for resale in any manner.

PUBLICATION ORDERING INFORMATION

LITERATURE FULFILLMENT:
Literature Distribution Center for ON Semiconductor
P.O. Box 5163, Denver, Colorado 80217 USA
Phone: 303-675-2175 or 800-344-3860 Toll Free USA/Canada
Fax: 303-675-2176 or 800-344-3867 Toll Free USA/Canada
Email: orderlit@onsemi.com

N. American Technical Support: 800-282-9855 Toll Free
USA/Canada
Europe, Middle East and Africa Technical Support:
Phone: 421 33 790 2910
Japan Customer Focus Center
Phone: 81-3-5773-3850

ON Semiconductor Website: www.onsemi.com
Order Literature: <http://www.onsemi.com/orderlit>
For additional information, please contact your local Sales Representative